

USER'S MANUAL

BV10.1MC

10.1" (256mm) WIDESCREEN FLIP-DOWN TFT MONITOR
INCLUDING TWO-PAIRS OF DUAL CHANNEL HEADPHONES

BOSS[®]
AUDIO SYSTEMS

BOSS Audio Systems
3451 Lunar Court • Oxnard, CA 93030
www.bossaudio.com | 800.999.1236
tech support: www.bossaudio.com/support



0913

USER'S MANUAL

BV10.1MC

10.1" (256mm) WIDESCREEN
FLIP-DOWN TFT MONITOR
INCLUDING TWO-PAIRS OF DUAL CHANNEL HEADPHONES



BOSS[®]
AUDIO SYSTEMS

Contents

Contents.....	01
Caution.....	02
Caution.....	03
Product Controls and Functions.....	04
Product Controls and Functions.....	05
Remote Control Diagram.....	06
Power And Mode Selection.....	07
Picture.....	08
Volume.....	09
System.....	10
Setup Key.....	11
Setup Menu.....	12
Setup Menu.....	13
DVD Functions.....	14
DVD Functions.....	15
DVD Functions.....	16
DVD Functions.....	17
DVD Functions.....	18
Connection Diagram.....	19
Installation.....	20
Interchangeabel housing change diagram.....	21
Disc Inform ation.....	22
Troubleshooting.....	23
Specifications.....	24

Caution

Please read and observe all warnings and instructions in this owner's manual and those marked on the unit. Retain this booklet for future reference.

There are two kinds of alarm symbols as follows:



WARNING

This symbol is intended to alert the user on the presence of dangerous voltage within the product's enclosure that may cause electric shock to you.



CAUTION

The exclamation point within an equilateral triangle is intended to alert the user to the presence of important operating and maintenance(servicing) instructions in the literature accompanying the product.



WARNING

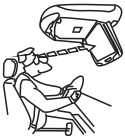

Hazard! do not operate this unit unless vehicle is parked in safe and legal area.



Do not mount the product where it will obstruct the deployment of the airbag or in an area where it would affect the vehicular control. Also be careful to avoid mounting the product where it can become hazardous during sudden stops or in the event of an accident.



Do not try and service these products yourself. Seek only a qualified service center or factory service center.



Do not place any liquids near the monitor. If any liquid is spilled on the unit, pull over to the side of the road, turn the ignition completely off and

dry the product with a towel. Do not operate the equipment again until all liquids have either evaporated or you have the unit inspected by a qualified technician at your local authorized dealer.



Be careful not to drop or apply pressure to the front panel of your video monitor. If the screen cracks due to misuse, your warranty will be void!



Be careful not to overload your cigarette lighter plug by adding more than one device at a time.



Use only a damp cloth to clean the screen and use only purified water on the cloth, wring out all excess water prior to wiping the screen. Do not use any cleaners or chemicals to clean the screen. In most cases a dry cloth will do!

Caution

CAUTION



Quality installations are best performed by qualified and certified installers.



Watching the monitor for an extended period of time without the engine running may deplete the vehicle's battery charge.



Don't touch the unit if there is lightning as this may cause an electric shock to you.



This product is designed for operation with a 12 Volt DC, negative ground vehicle. It is not suitable for operation under other conditions or voltages.



Do not cover the heater ducts or vents as this may cause a fire or electric shock



Do not bring magnetic items such as credit cards and other cards with magnetic strips near the monitor as this may cause damage to the unit and/or magnetic item



Check Point

1. The operating temperature of this product is limited to $-10^{\circ}\text{C} \sim +60^{\circ}\text{C}$.
Your vehicle can reach temperatures up to 80°C in the summer time.
2. From time to time when your vehicle is extremely hot or cold you must allow time for your air conditioner or heater to cool or heat the vehicle and for operating temperatures to return to normal operating ranges. Your monitor will return to its normal functions when these operating temperature are achieved.
3. Your optimum picture quality is achieved when you are directly in front of the monitor (± 30 degrees).
4. Do not open covers and repair yourself. Refer servicing to qualified personnel.
5. DVD Players use an invisible laser beam which can cause hazardous radiation exposure. Be sure to operate the unit correctly as instructed.
6. Do not turn ignition off while a disc is playing. It can cause damage to the DVD Player.

Product Controls and Functions

LAMP

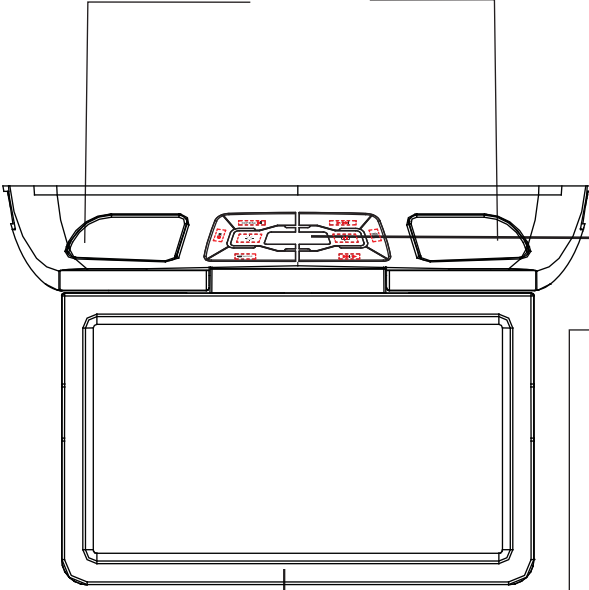

Remote Control Eye.

This allows transmitting of the remote control's IR signals for controlling all functions of your monitor.



Wireless Infrared (IR) Transmitter.

IR audio signals are transmitted wirelessly to optional IR headphones

Product Controls and Functions

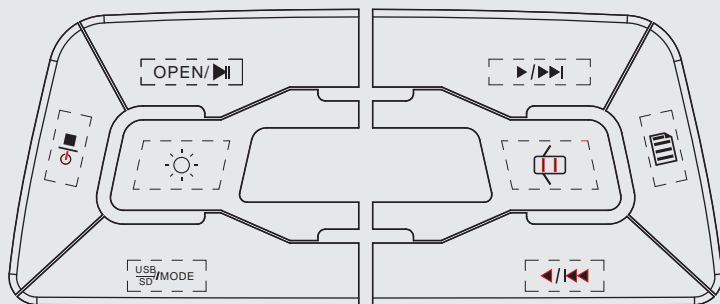

REMARKS:

Following functions work when long pressing 1-2 seconds.

"OPEN" "▶" "◀" "■" "USB/SD" "■" "■"

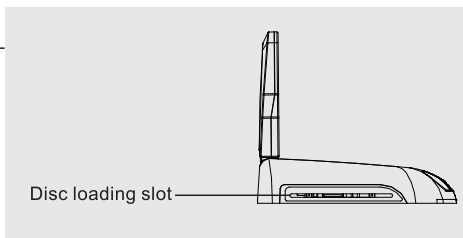
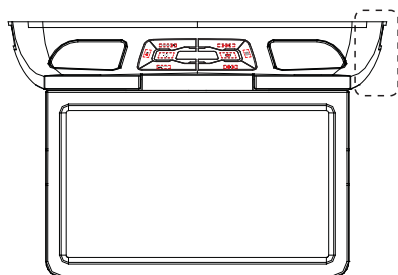

* Caution

Do not bring magnetic items such as credit cards or other cards with magnetic strips near the monitor as this may cause damage to the unit and/or magnetic item.

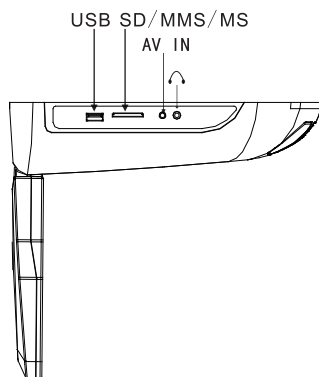

Remote Control Diagram

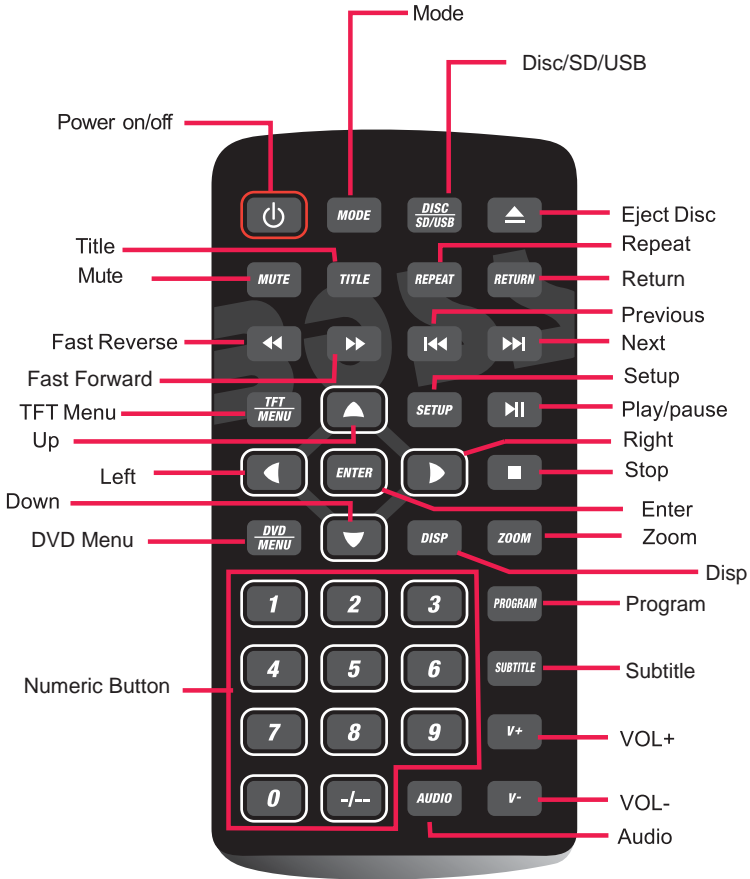

BOSS

Power And Mode Selection

● Mute Function

Mute the audio sound.

1. Press the **MUTE** button on the remote control to mute the audio.

When the mute is on, press the **MUTE** button again on the remote control to play the audio.

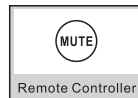

● Volume Control

Control the audio volume to your desired setting

The audio volume is controlled by pressing the **V +/-** buttons on the remote control, DVD and another mode.

● Mode Setting

Select the desired mode by entering MENU -LIST4 **MODE** button on the remote control.

Mode will be changed as belowed.
DVD → AV1 → AV2

● DVD Mode

1. Select the **DVD** mode by pressing the **MODE** button on the remote control.

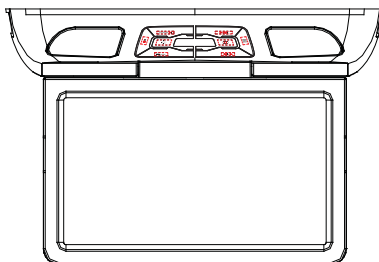

● AV In Mode

1. Connect the external devices.
(Refer to Connection Diagram on page 19).
2. Turn the power ON the unit and external devices.
3. Play the external device.

PICTURE

Picture Control

● BRIGHTNESS/CONTRAST/COLOR/HUE

Selection of **BRIGHTNESS/CONTRAST/COLOR/HUE** and change the picture condition as your taste,

1、 Bring up the on-screen function menu by pressing the MENU button on the unit or the TFT MENU button on the remote control.

2、 Select the desired menu by pressing the MENU button on the unit or the TFT MENU button on the remote control .

3、 Change the figure of desired function to adjust Contrast, Brightness, Color, ect.

OPTION

1、 Bring up the on-screen function menu by pressing the MENU button on the unit or the TFT MENU button on the remote control.

2、 Select the Language ,ZOOM by pressing the menu button on the unit or TFT menu button on the remote control.

3、 Control the desired mode by pressing the ◀/▶ buttons on the unit or the ◀/▶ buttons on the remote control as you want.

IR Transmitter

A built-in dual channel IR transmitter is built-in to the unit to allow for audio to be transmitted wirelessly to your IR headphones. Both channels A and B can be selected on our optional dual channel IR headphones.

- 1、Bring up the on-screen function menu by pressing the MENU button on the unit or the TFT MENU button on the remote control.
- 2、Select and open “IR”.
- 3、Press the ◀/▶ button on the unit or ◀/▶ button on the remote control to select the A or B IR channel at your choice,

FM Transmitter

A built-in FM Transmitter allow audio to be sent to your car's speakers

- 1、Bring up the on-screen function menu by pressing the MENU button on the unit or the TFT MENU button on the remote control.
- 2、Select the desired menu by pressing the menu button on the unit or the TFT MENU button on the remote control.
- 3、Adjust the Radio frequency from 87.7MHZ~107.9MHZ by pressing the ◀/▶ on the unit or the ◀/▶ buttons on the remote control.

SYSTEM

SYSTEM

- 1、 Bring up the on-screen function menu by pressing the MENU button on the unit or the TFT MENU button on the remote control.
- 2、 Select the S-COLOR by pressing the menu button on the unit or the TFT menu button on the remote control.
- 3、 Control the desired OSD and color by pressing the ◀/▶ buttons on the unit or the ◀/▶ buttons on the remote control .

CLOCK

- 1、 Bring up the on-screen function menu by pressing the MENU button on the unit or the TFT MENU button on the remote control.
- 2、 Select CLOCK and set to the correct time.
- 3、 Then filled in a figure of the SLEEP, TIME, OFF-TIME, ON-TIME by click your remote control or pressing the ◀/▶ buttons on the unit or the ◀/▶ buttons on the remote control .

SETUP KEY

• SETUP KEY

Press the SETUP button to enter the SETUP MENU as shown below.

Inside the DVD SETUP MENU, three categories SYSTEM, LANGUAGE, VIDEO, could be chosen.

Users can adjust or choose different options included in the DVD disc that is playing.

1. SYSTEM SETUP

A. TV SYSTEM



B. POWER RESUME



C. TV TYPE



D. PASSWORD (0000)



E. RATING



F. DEFAULT



SETUP MENU

2. LANGUAGE SETUP

A. OSD LANGUAGE



B. AUDIO LANG



C. SUBTITLE LANG



D. MENU LANG



SETUP MENU

3. VIDEO SETUP

A. BRIGHTNESS



B. CONTRAST



C. HUE



D. SATURATION



E. SHARPNESS



DVD FUNCTIONS

EJECT

Pressing the EJECT button changes the play mode.

VOL+ / VOL-

To adjust the audio output level of the speaker from 0 to 60.

MUTE



Pressing of the MUTE button changes the play mode.

OSD	CONDITION
Mute	Mute
Mute off	Mute off

PLAY OR PAUSE(▶||)

[DVD] / [AUDIO] / [Mp3]

Use this button to select a particular scene or play the disc. Most DVD discs will play automatically.

OSD	CONDITION
	Play Disc
	Pause

AUDIO

[DVD]

Change the audio output type.
(If the loaded disc supports available audio type.)

OSD	CONDITION
1/2:AC3 2CH English	2 Channel
2/2:AC3 5.1CH English	5.1 Channel

[VCD] [AUDIO]

Change the audio output type.
(If the loaded disc supports available audio type.)

OSD	CONDITION
Stereo	Stereo
Mono Left	Mono Left
Mono Right	Mono Right
Mix Mono	Mix Mono

[MP3]

An invalid button press.

DVD FUNCTIONS

STOP(■)

[DVD] / [AUDIO]

Press the STOP button once to stop the movie temporarily. Press the Play/Pause button to resume play and pause. Press STOP button twice to completely stop and reset the memory. Pressing Play/Pause button again will send you back to the beginning of the disc.

OSD	CONDITION
1.Time Press Play Key To Continue	Stop
2.Time	Disc Stop

[MP3]

Press the STOP button to stop the disc. Press the Play/Pause button to display the first file of the disc.

OSD	CONDITION
1.Time Stop	Stop

NUMERIC BUTTONS

[DVD]

Numeric buttons 0 to 9 are used to enter the number of tracks, the number of the DVD chapter, time data, etc.

[AUDIO]

You can select a track by pressing the corresponding numeric button.

OSD	CONDITION
Select Track : __	Stop

[MP3]

You can select a track in the folder by pressing the corresponding numeric button.

OSD	CONDITION
__ : __	Select track no

SETUP

Use to set various functions according to your individual preference.

MENU

[DVD]

The menu of a DVD disc varies.

The content of the menu on the screen is dependent on the particular DVD.

[AUDIO]/[MP3] ⓪

An invalid button press.

DVD FUNCTIONS

TITLE

[DVD]

Used to display the title menu of the loaded DVD disc.
(This function is disc-dependent.)

[AUDIO] / [Mp3] ⓪

An invalid button press.

FAST REVERSE SEARCHING(◀◀)

[DVD]

Pressing FR button changes the play mode as follows:

OSD	CONDITION
FR 2X	2X rewind search
FR 4X	4X rewind search
FR 8X	8X rewind search
FR 16X	16X rewind search
FR 32X	32X rewind search
PLAY	PLAY

[AUDIO] / [DVD]

Pressing FR button changes the play mode as follows:

OSD	CONDITION
FR 2X	2X rewind play
FR 4X	4X rewind play
FR 8X	8X rewind play
FR 16X	16X rewind play
FR 32X	32X rewind play
PLAY	PLAY

[MP3] / [DVD]

Pressing FR button changes the play mode as follows:

OSD	CONDITION
FR 2X	2X rewind play
FR 4X	4X rewind play
FR 8X	8X rewind play
FR 16X	16X rewind play
FR 32X	32X rewind play
PLAY	PLAY

DVD FUNCTIONS

FAST FORWARD SEARCHING(▶▶)

[DVD]

Pressing FR button changes the play mode as follows:

OSD	CONDITION
FF 2X	2X forward search
FF 4X	4X forward search
FF 8X	8X forward search
FF 16X	16X forward search
FF 32X	32X forward search
PLAY	PLAY

[AUDIO] / [VCD]

Pressing FR button changes the play mode as follows:

OSD	CONDITION
FF 2X	2X forward play
FF 4X	4X forward play
FF 8X	8X forward play
FF 16X	16X forward play
FF 32X	32X forward play
PLAY	PLAY

[Mp3]

Pressing FR button changes the play mode as follows:

OSD	CONDITION
FF 2X	2X forward play
FF 4X	4X forward play
FF 8X	8X forward play
FF 16X	16X forward play
FF 32X	32X forward play
PLAY	PLAY

PREV(◀◀)

[DVD] / [VCD]

Used to move to the previous chapter from the current chapter.

[AUDIO] / [MP3]

Used to move to the previous track.

NEXT(▶▶)

[DVD] / [VCD]

Used to move to the next chapter from the current chapter.

[AUDIO] / [MP3]

Used to move to the next track from the current track.

DVD FUNCTIONS

REPEAT

[DVD]

Pressing REPEAT button changes the play mode as follows.

OSD	CONDITION
Chapter	Repeat chapter
Title	repeat title
All	all
	repeat off

[VCD]

An invalid button press.

[AUDIO]

Pressing REPEAT button changes the play mode as follows.

OSD	CONDITION
Track	Repeat single
All	all
	repeat off

[MP3]

Used to change the play mode. Pressing REPEAT button changes the play mode as follows:

OSD	CONDITION
Repeat One	Single
Repeat Folder	repeat folder
Folder	repeat folder one time
Shuffle	all
Random	random play
Single	single play

Connection Diagram

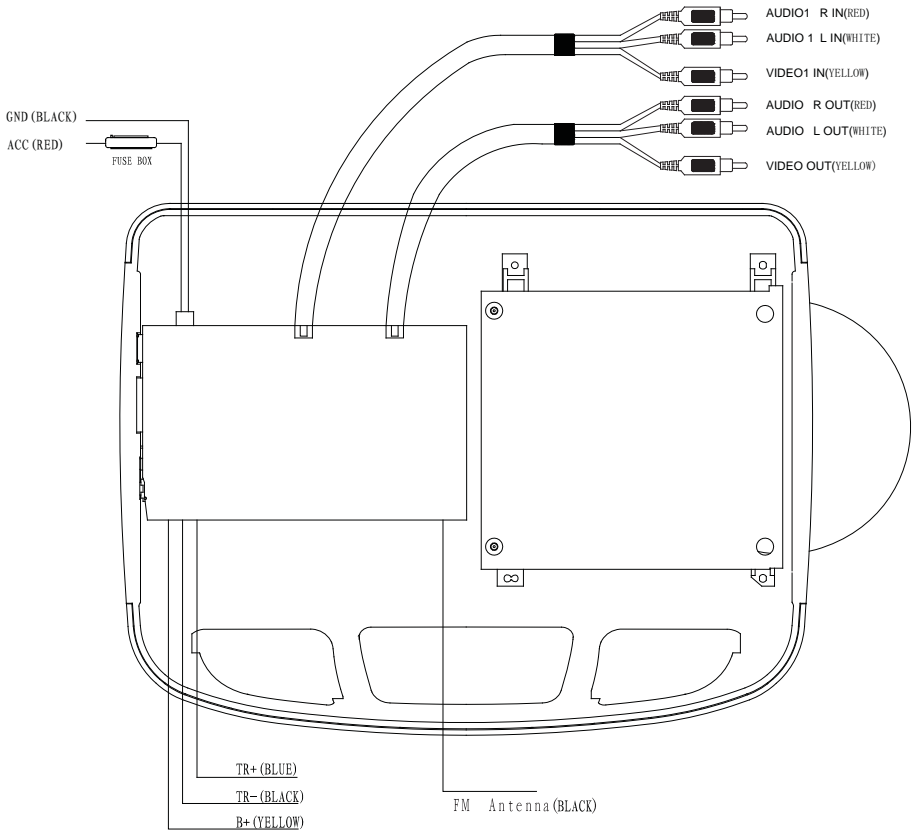

*How to connect the DOOR TRIGGER wire

1. Connect yellow positive (+) wire
2. Check your vehicle's door trigger is positive "+" or negative "-"
3. Connect unit one correct trigger wire (positive "+" or negative "-") with vehicle's door trigger in accordance

Installation

1. Open the box and check the contents.

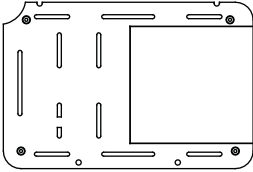

Mounting Plate

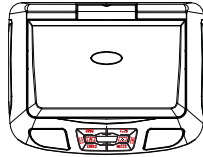

UNIT

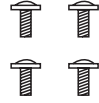

SCREW B

2. Align mounting plate with installation position and secure plate with screws

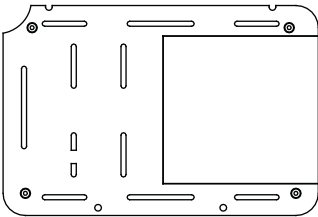

Use the correct screws that matches the car.

3. Tighten the unit with the supplied SCREW B.

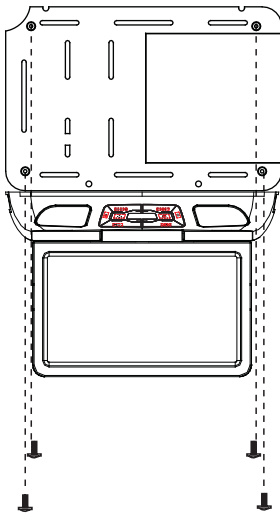

Interchangeable housing change diagram

Assembling the shroud

Begin by hooking the area and press the shroud over the pod. The shroud will snap in place. Tightening the shroud by screws supplied. Removing shroud

Release screws and take out the shroud as diagram

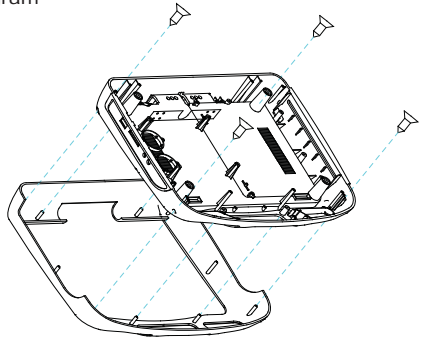
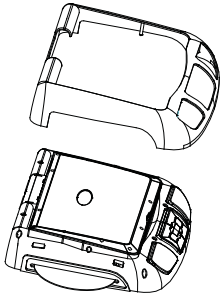

Removing Screen back From The Housing

working on a soft surface to avoid damaging the plastic.

Insert the supplied pry tool between the Housing Screen back, then press the pry tool to release the Screen back.

Assembling the screen back

Begin by hooking the area and press the Shroud/Screenback over the pod. The Shroud/Screen back will snap in place.

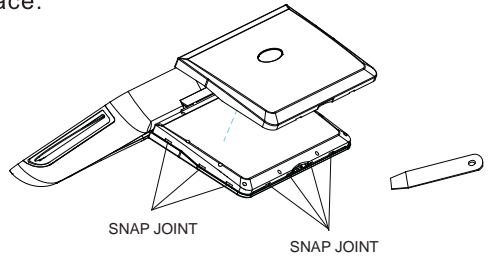
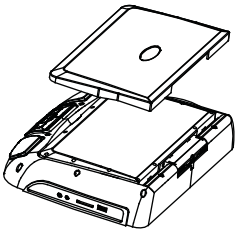

Swivel cover moving/assembling

Use supplied small tool to insert the hook hole, and get the cover off.

Pressing the swivel cover over the swivel, the cover will snap in place

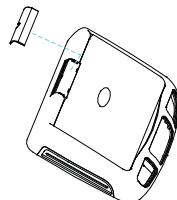
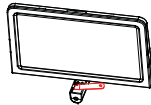
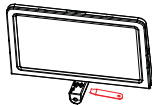
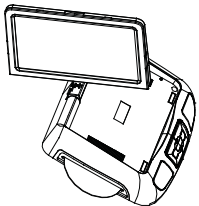

Disc Information

DVD features

DVD discs provide high-resolution images with high-quality sound and surround sound effects . This DVD player can play not only DVD discs of various versions, but also S-VCD, VCD, audio CD and Mp3 disc . Each disc plays only the information saved on it , and some functions cannot be utilized.

Discs that cannot be played

DVD-RW, DVD -REM , CD-ROM , CD-EXTRA discs cannot be played on this unit. Also , a CD or a CD-RW which was recorded on special software cannot be played.

Region code

Your DVD player is designed and manufactured to region management information that is recorded on a DVD disc . Please check the region code.

1: North America 2: Japan 3 : Korea and Southeast Asia
4: Australia, Mid & South America 5: Russia 6: China

Copyright protection

This product incorporates copyright protection technology that is protected by methods claims of certain U.S. Patents and other intellectual property rights owned by the Macrovision Corporation and other rights. Owner`s use of this copyright protection technology must be authorized by the Macrovision Corporation , and is intended for home and other limited viewing uses only unless otherwise authorized by the Macrovision Corporation.

How to handle the disc

Don`t touch the shiny side of the disc (the side with the embedded information). Don`t stick a label or a glue-based note on eight side of the disc . Don`t use discs that have glue or a damaged gluey label-it might result in damage to your DVD player . Don`t put discs in the sunshine . Park your car in the shade.



Caution

Wipe softly with a wet cloth and then with a dry one.
Before playback , wipe the disc outward from the center with a clean cloth.
Do not use any type of solvent such as thinner , benzene , commercially-available cleaners or antistatic spray.
To avoid damaging your DVD player , don`t use a scratched disc.



Troubleshooting

Symptom	Items to check	Actions to be Taken
Button does not work	Is the power turned on?	Check the car battery capacity
No sound	Is the audio cable set to receive the DVD signal output? Is the audio cable connected securely? Is the monitor connected with the audio turned on ? Is the digital audio output set in the correct position?	Select the correct input mode for the audio receiver. Connect the audio cable into the jacks securely. Turn on the monitor connected to the audio cable does not work properly Set the Digital Audio Output to the correct position, and then turn on the DVD player by pressing the POWER button.
Remote control does not work properly.	Is the remote control facing the remote sensor? Is the distance too far? Is there any obstacle in the middle? Is the battery exhausted?	Point the remote control to the remote sensor of the product. Use the remote control within 5m Remove the obstacle. Replace with new batteries Check antenna connection.

Specifications



Check point

When a disc is brought from a cold environment to a hot one , there may be condensation on the face of the disc or pick up lens. This can affect the operation of the unit.

- 1.Remove the disc from the DVD player.
- 2.Turn on the power and leave it on for an hour to vaporize the condensation.
- 3.You can operate the DVD player without any problems.

Screen size	10. 1" TFT LCD Panel
Power	DC12V
Consumption	10W
Screen Format	16:9
Resolution	1024(H)x600(V)xRGB
Color System	NTSC/PAL / Auto Selection
A/V Input	2EA
A/V Output	1EA
Dimension	325(W)X245.5(D)X55(H)mm/12.8(W)X9.6(D)X2.2(H)

Note : This equipment has been tested and has been found to comply with the limits for a Class A digital device , pursuant to part 15 of the FCC Rules .These limits are designed to provide reasonable protection against harmful interference when the equipment is operated in a commercial environment .This equipment generates , uses , and can radiate radio frequency energy and , if not installed and used in accordance with the instruction manual , may cause harmful interference to radio communications . Operation of this equipment in a residential area is likely to cause harmful interference in some case the user will be required to correct the interference at his own expense.